

T-1 PACKAGE PIN PHOTODIODE

MID-30A12

Description

The MID-30A12 is a PIN photodiode mounted in a lensed, special dark plastic package. The lensing effect of the package allows an acceptance half view angle of 10° that is measured from the optical axis to the half power point.

Features

- High photo sensitivity
- Low junction capacitance
- High cut-off frequency
- Fast switching time
- Good spectral matching IRED ($\lambda_p=940\text{nm}$) type.

Package Dimensions

Unit : mm (inches)

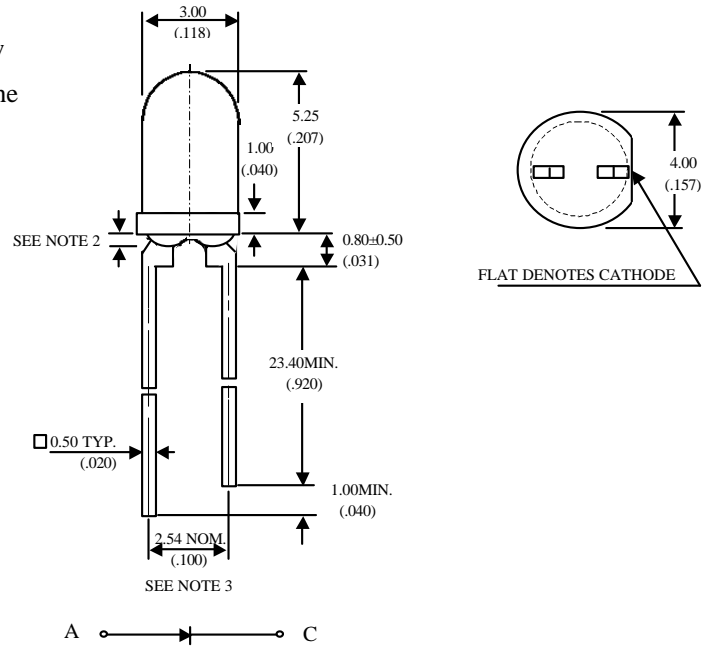

Notes :

1. Tolerance is ± 0.25 mm (.010") unless otherwise noted.
2. Protruded resin under flange is 0.8 mm (.031") max.
3. Lead spacing is measured where the leads emerge from the package.

Absolute Maximum Ratings

@ $T_A=25^\circ\text{C}$

Parameter	Maximum Rating	Unit
Power Dissipation	100	mW
Reverse Break Down Voltage	30	V
Operating Temperature Range	-55°C to +100°C	
Storage Temperature Range	-55°C to +100°C	
Lead Soldering Temperature	260°C for 5 seconds	

UNI

Unity Opto Technology Co., Ltd.

02/04/2002

Optical-Electrical Characteristics

@ T_A=25°C

Parameter	Test Conditions	Symbol	Min.	Typ.	Max.	Unit
Reverse Break Down Voltage	I _R =100μA Ee=0	V _{(BR)R}	30			V
Reverse Dark Current	V _R =10V Ee=0	I _D			30	nA
Open Circuit Voltage	λ=940nm Ee=0.1mW/cm ²	V _{OC}		350		mV
Rise Time	V _R =10V λ=940nm	Tr		40		nsec
Fall Time	R _L =1KΩ	Tf		30		
Light Current	V _R =5V, λ=940nm Ee=0.1mW/cm ²	I _L	1	4		μA
Total Capacitance	V _R =3V, f=1MHZ Ee=0	C _T		15		pF
Half Acceptance Angle	V _R =5V Ee=0.1mW/cm ²	2θ _{1/2}		25		deg.

Typical Optical-Electrical Characteristic Curves

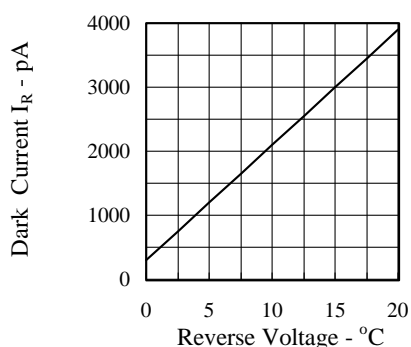

FIG.1 DARK CURRENT VS REVERSE VOLTAGE
T_{AMB}=25°C, Ee=0 mW/cm²

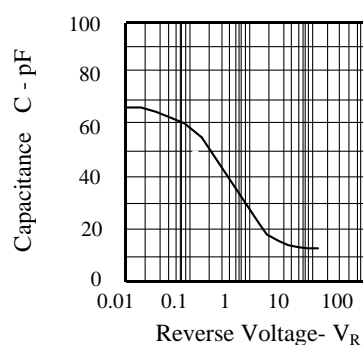

FIG.2 CAPACITANCE VS. REVERSE VOLTAGE
F=1MHZ ; Ee=0mW/cm²

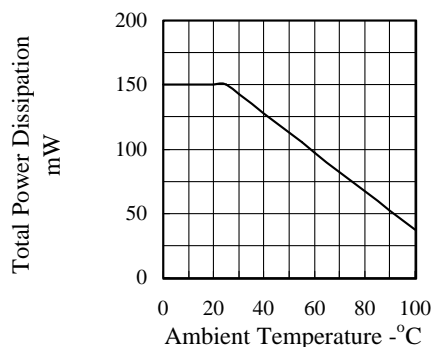

FIG.3 TOTAL POWER DISSIPATION VS. AMBIENT TEMPERATURE

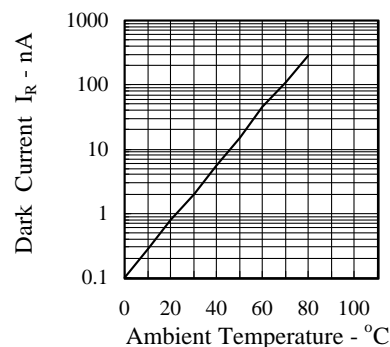

FIG.4 DARK CURRENT VS AMBIENT TEMPERATURE
V_R=10, Ee=0 mw/cm²

Typical Optical-Electrical Characteristic Curves

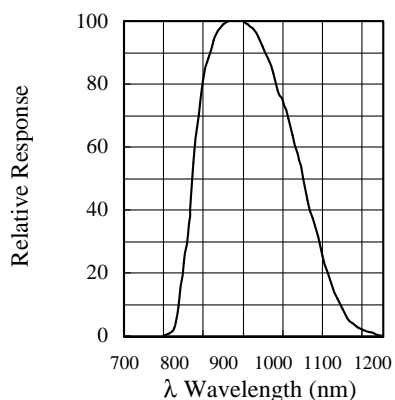

FIG.5 RELATIVE SPECTRAL SENSITIVITY VS. WAVELENGTH

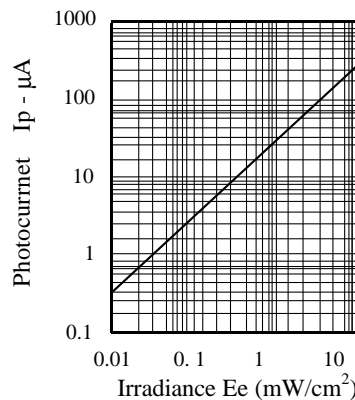

FIG.6 PHOTOCURRENT VS. IRRADIANCE = 950 nm

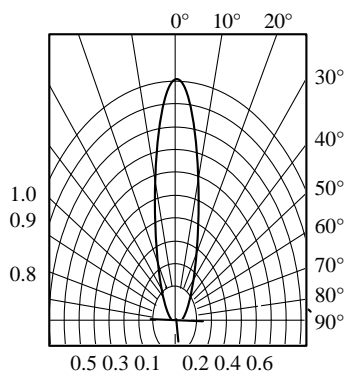

FIG.7 SENSITIVITY DIAGRAM